

Features

- Low insertion loss in pass band
- High attenuation levels
- High rejection of out-of-band frequencies
- Small footprint: $< 1.4 \text{ mm}^2$

Benefits

- Very low profile ($< 600 \mu\text{m}$ after reflow)
- High Q, low loss
- High RF performance
- Tight tolerance
- Bill of materials and area reduction

Applications

- WLAN
- Bluetooth
- Mobile phone application
- Wireless networking

Description

This diplexer targets the use of dual band 2.4 GHz and 5 GHz. The DIP2450-01D3 is a diplexer dedicated to the WLAN/BT application.

It is designed using STMicroelectronics IPD (integrated passive device) technology on non conductive glass substrate to optimize RF performance.

Figure 1. Pin configuration (bump view)

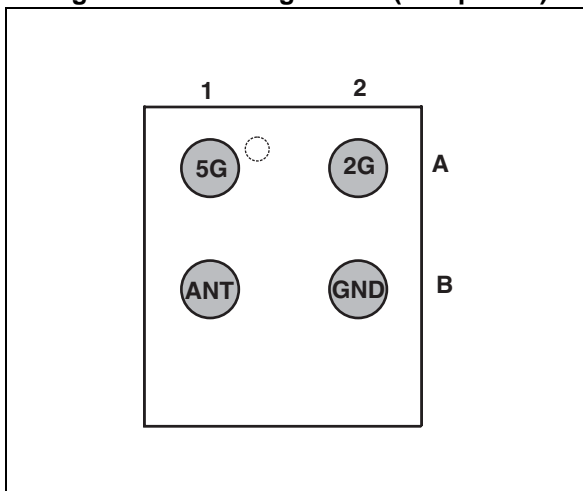

1 Characteristics

Table 1. Absolute rating (limiting values)

Symbol	Parameter	Value			Unit
		Min.	Typ.	Max.	
P _{AV}	Average power			27	dBm
V _{ESD} antenna and 2G ports	ESD ratings: MIL STD883C (HBM:C = 100 pF, R = 1.5 kΩ, air discharge) Charged device model (CDM) Machine model (MM: C = 200 pF, R = 25 Ω, L = 500 nH)	400 500 100			V
T _{OP}	Operating temperature range	-40		+85	°C

Table 2. Electrical characteristics and RF performance (T_{amb} = 25 °C)

Symbol	Parameter	Test condition	Value			Unit
			Min.	Typ.	Max.	
Pass band						
f	2 G band pass		2400		2483.5	MHz
	5 G band pass		4900		5850	MHz
Z	Nominal impedance			50		Ω
Return loss		All ports			-17	dB
S21	2 G to antenna insertion loss	2400 to 2483.5 MHz		0.6	0.7	dB
S31	5 G to antenna insertion loss	4900 to 5850 MHz		0.6	0.7	dB
Attenuation						
S21	2 G to antenna attenuation	4900 to 5850 MHz	20			dB
S31	5 G to antenna attenuation	2400 to 2483.5 MHz	18			dB
Out of band attenuation						
S21	2 G to antenna attenuation	5850 to 7000 MHz	15			dB
		7000 to 9500 MHz	9			
		9800 to 10500 MHz	16			
S31	5 G to antenna attenuation	9800 to 11650 MHz	11			dB

1.1 Measured performance

Figure 2. 2 G and 5 G forward transmission ($T_{amb} = 25\text{ }^{\circ}\text{C}$)

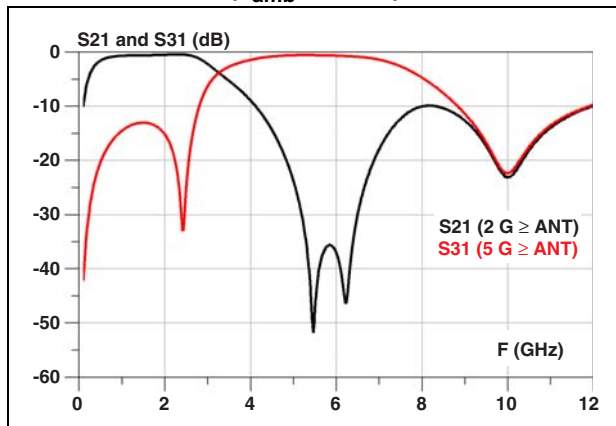

Figure 3. 2 G, 5 G and antenna reflection coefficient ($T_{amb} = 25\text{ }^{\circ}\text{C}$)

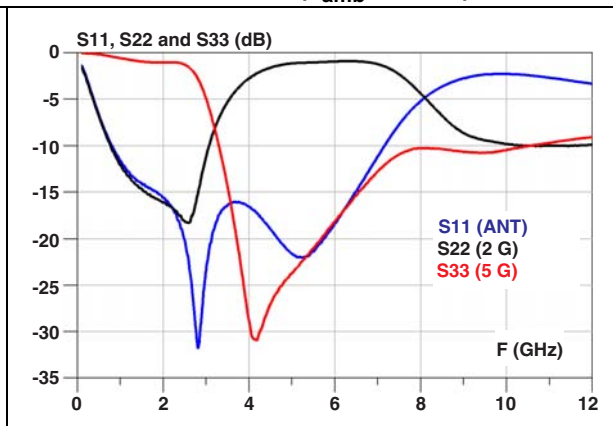

Figure 4. 2 G insertion loss ($T_{amb} = 25\text{ }^{\circ}\text{C}$)

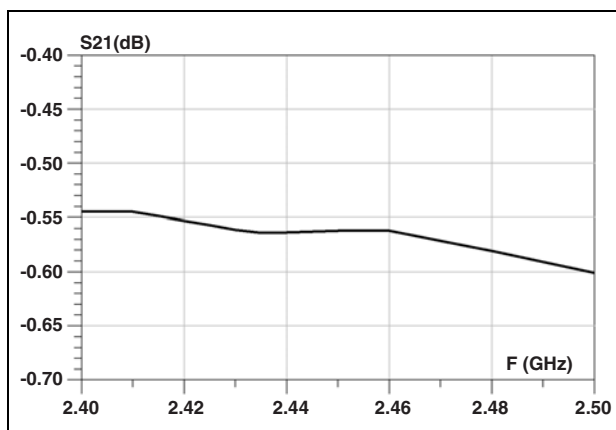

Figure 5. 2 G attenuation in 5 G band ($T_{amb} = 25\text{ }^{\circ}\text{C}$)

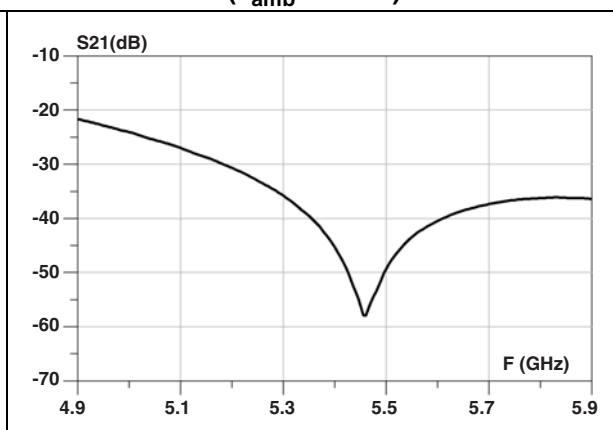

Figure 6. 2 G attenuation in high frequency band ($T_{amb} = 25\text{ }^{\circ}\text{C}$)

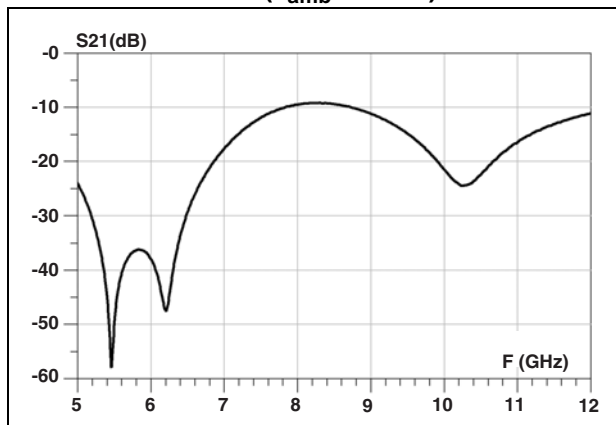

Figure 7. 2 G return loss ($T_{amb} = 25\text{ }^{\circ}\text{C}$)

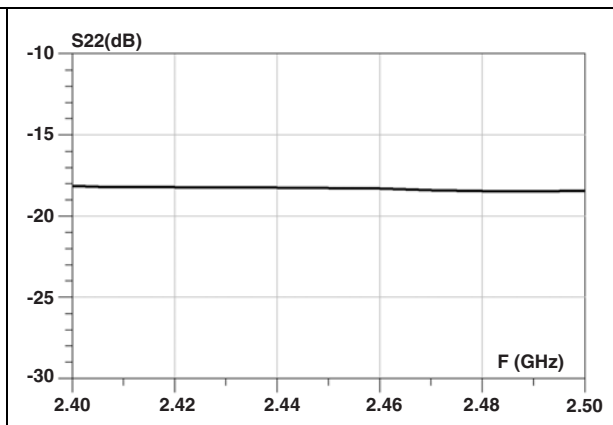

Figure 8. Antenna return loss in 2 G band
($T_{amb} = 25\text{ }^{\circ}\text{C}$)

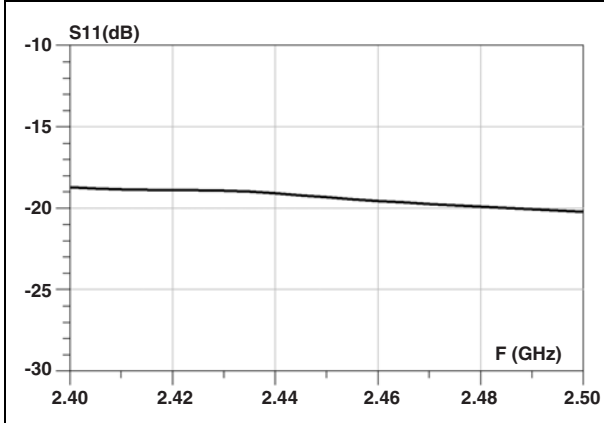

Figure 9. Antenna return loss in 5 G band
($T_{amb} = 25\text{ }^{\circ}\text{C}$)

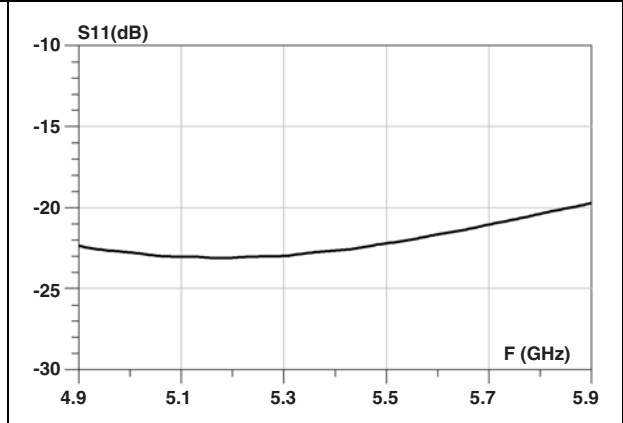

Figure 10. 5 G insertion loss ($T_{amb} = 25\text{ }^{\circ}\text{C}$)

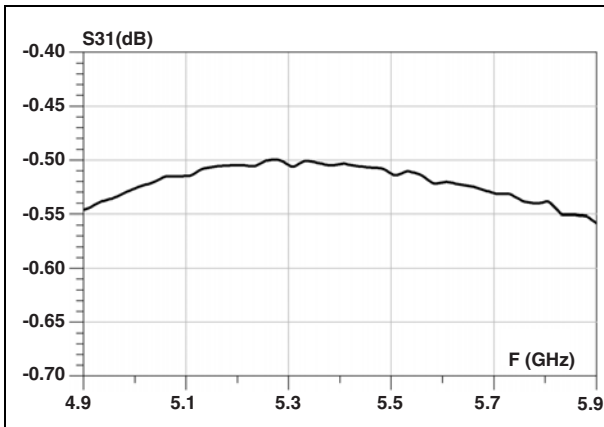

Figure 11. 5 G attenuation in 2 G band
($T_{amb} = 25\text{ }^{\circ}\text{C}$)

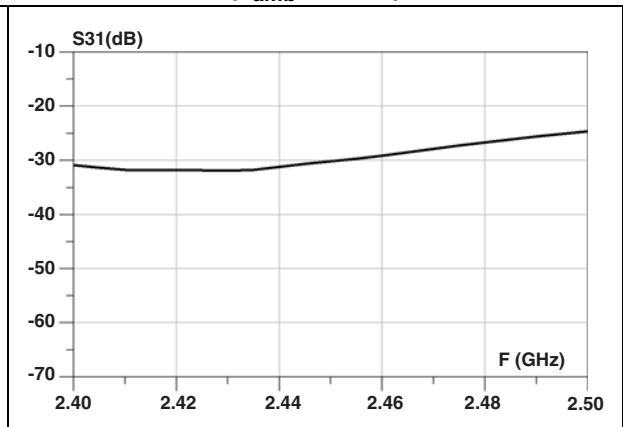

Figure 12. 5 G attenuation in high frequency band ($T_{amb} = 25\text{ }^{\circ}\text{C}$)

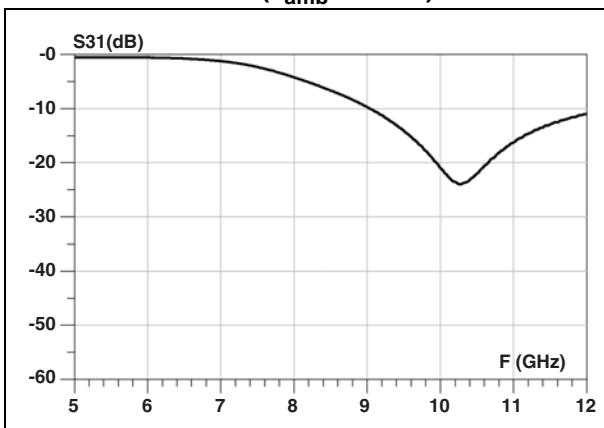

Figure 13. 5 G return loss ($T_{amb} = 25\text{ }^{\circ}\text{C}$)

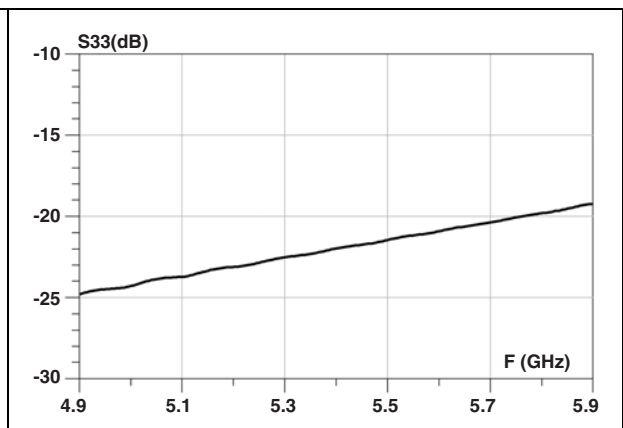

Figure 14. 2 G to 5 G isolation ($T_{amb} = 25\text{ }^{\circ}\text{C}$)

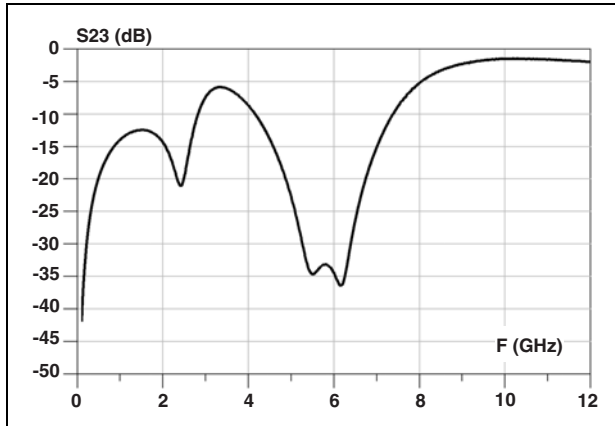

Figure 15. 2 G to 5 G isolation in 2 G band ($T_{amb} = 25\text{ }^{\circ}\text{C}$)

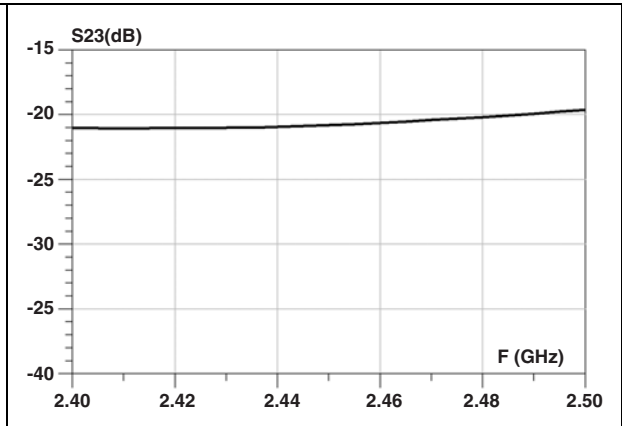
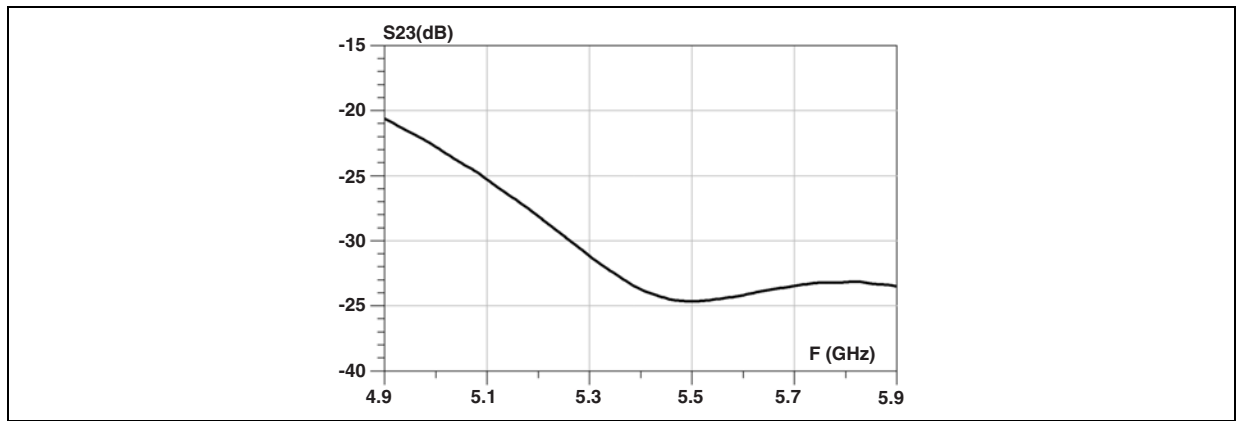

Figure 16. 2 G to 5 G isolation in 5 G band ($T_{amb} = 25\text{ }^{\circ}\text{C}$)



2 Application information

Figure 17. Application schematic

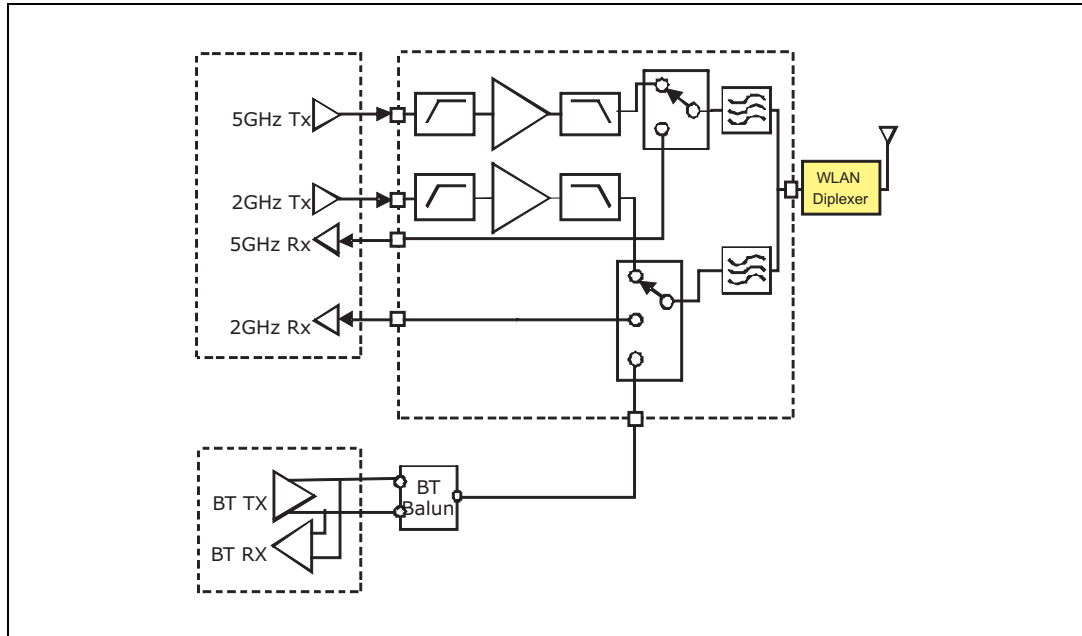
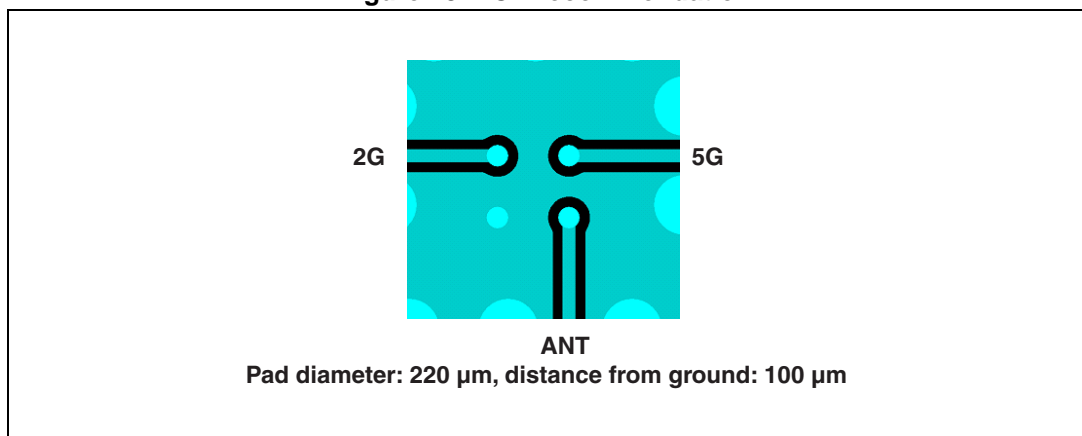

Figure 18. PCB recommendation



3 Package information

In order to meet environmental requirements, ST offers these devices in different grades of ECOPACK® packages, depending on their level of environmental compliance. ECOPACK® specifications, grade definitions and product status are available at: www.st.com. ECOPACK® is an ST trademark.

Figure 19. Package dimensions

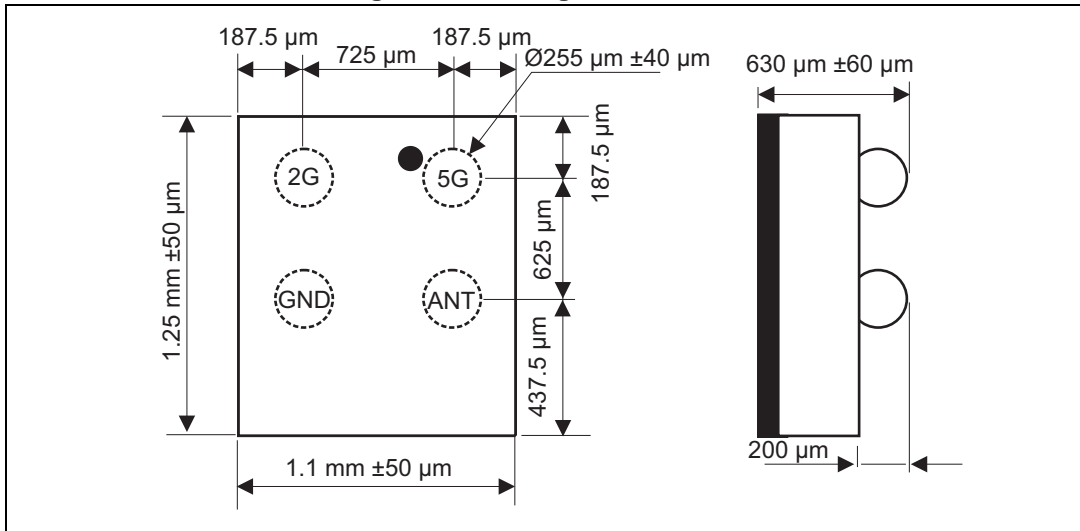

Figure 20. Footprint

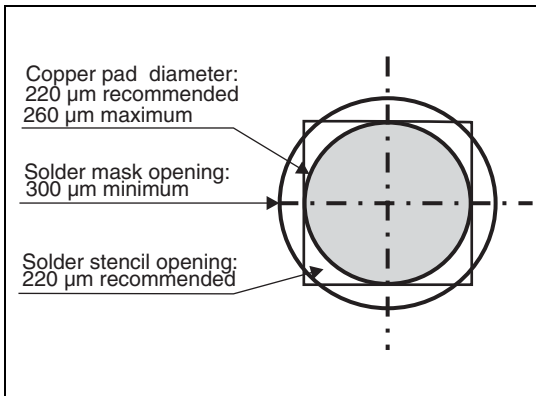

Figure 21. Marking

Dot, ST logo
 ■ ECOPACK status
 xx = marking
 z = manufacturing location
 yww = datecode
 (y = year
 ww = week)

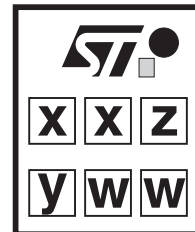
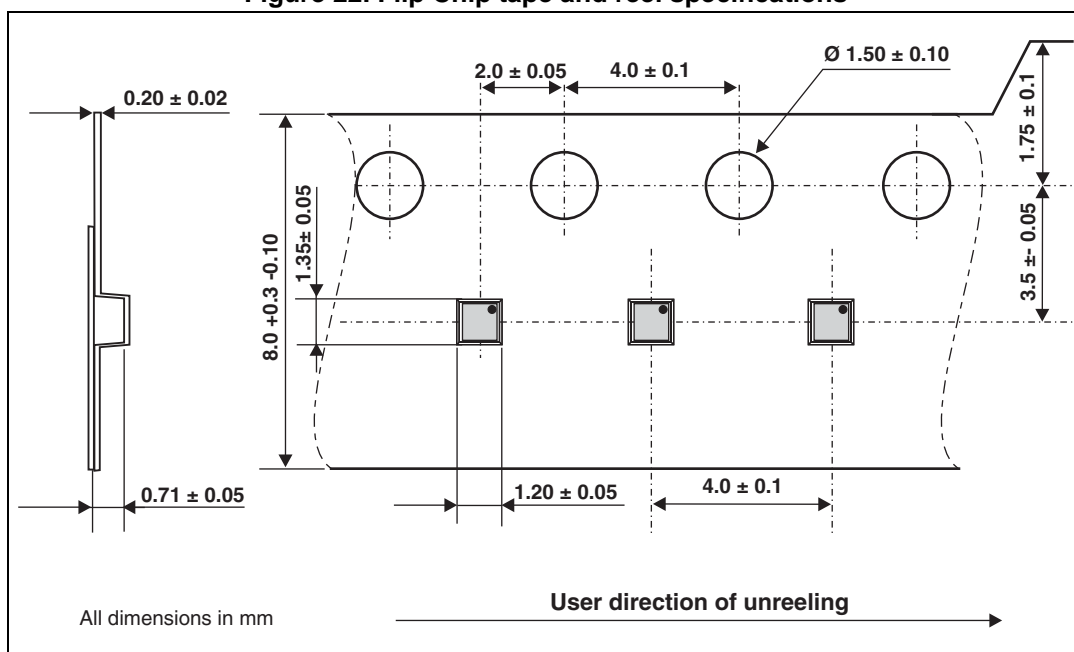

Figure 22. Flip Chip tape and reel specifications



4 Ordering information

Table 3. Ordering information

Order code	Marking	Package	Weight	Base qty	Delivery mode
DIP2450-01D3	SA	Flip Chip	1.88 mg	5000	Tape and reel (7")

5 Revision history

Table 4. Document revision history

Date	Revision	Changes
27-June-2012	1	Initial release
07-May-2014	2	Updated Figure 19: Package dimensions .

Please Read Carefully:

Information in this document is provided solely in connection with ST products. STMicroelectronics NV and its subsidiaries ("ST") reserve the right to make changes, corrections, modifications or improvements, to this document, and the products and services described herein at any time, without notice.

All ST products are sold pursuant to ST's terms and conditions of sale.

Purchasers are solely responsible for the choice, selection and use of the ST products and services described herein, and ST assumes no liability whatsoever relating to the choice, selection or use of the ST products and services described herein.

No license, express or implied, by estoppel or otherwise, to any intellectual property rights is granted under this document. If any part of this document refers to any third party products or services it shall not be deemed a license grant by ST for the use of such third party products or services, or any intellectual property contained therein or considered as a warranty covering the use in any manner whatsoever of such third party products or services or any intellectual property contained therein.

UNLESS OTHERWISE SET FORTH IN ST'S TERMS AND CONDITIONS OF SALE ST DISCLAIMS ANY EXPRESS OR IMPLIED WARRANTY WITH RESPECT TO THE USE AND/OR SALE OF ST PRODUCTS INCLUDING WITHOUT LIMITATION IMPLIED WARRANTIES OF MERCHANTABILITY, FITNESS FOR A PARTICULAR PURPOSE (AND THEIR EQUIVALENTS UNDER THE LAWS OF ANY JURISDICTION), OR INFRINGEMENT OF ANY PATENT, COPYRIGHT OR OTHER INTELLECTUAL PROPERTY RIGHT.

ST PRODUCTS ARE NOT DESIGNED OR AUTHORIZED FOR USE IN: (A) SAFETY CRITICAL APPLICATIONS SUCH AS LIFE SUPPORTING, ACTIVE IMPLANTED DEVICES OR SYSTEMS WITH PRODUCT FUNCTIONAL SAFETY REQUIREMENTS; (B) AERONAUTIC APPLICATIONS; (C) AUTOMOTIVE APPLICATIONS OR ENVIRONMENTS, AND/OR (D) AEROSPACE APPLICATIONS OR ENVIRONMENTS. WHERE ST PRODUCTS ARE NOT DESIGNED FOR SUCH USE, THE PURCHASER SHALL USE PRODUCTS AT PURCHASER'S SOLE RISK, EVEN IF ST HAS BEEN INFORMED IN WRITING OF SUCH USAGE, UNLESS A PRODUCT IS EXPRESSLY DESIGNATED BY ST AS BEING INTENDED FOR "AUTOMOTIVE, AUTOMOTIVE SAFETY OR MEDICAL" INDUSTRY DOMAINS ACCORDING TO ST PRODUCT DESIGN SPECIFICATIONS. PRODUCTS FORMALLY ESCC, QML OR JAN QUALIFIED ARE DEEMED SUITABLE FOR USE IN AEROSPACE BY THE CORRESPONDING GOVERNMENTAL AGENCY.

Resale of ST products with provisions different from the statements and/or technical features set forth in this document shall immediately void any warranty granted by ST for the ST product or service described herein and shall not create or extend in any manner whatsoever, any liability of ST.

ST and the ST logo are trademarks or registered trademarks of ST in various countries.

Information in this document supersedes and replaces all information previously supplied.

The ST logo is a registered trademark of STMicroelectronics. All other names are the property of their respective owners.

© 2014 STMicroelectronics - All rights reserved

STMicroelectronics group of companies

Australia - Belgium - Brazil - Canada - China - Czech Republic - Finland - France - Germany - Hong Kong - India - Israel - Italy - Japan - Malaysia - Malta - Morocco - Philippines - Singapore - Spain - Sweden - Switzerland - United Kingdom - United States of America

www.st.com